

# F-86 Sabre 1/32

The die-cut mask for accurate canopy frame painting of the *Hasegawa* scale 1/32 KIT

## eduard MASK

### JX 054

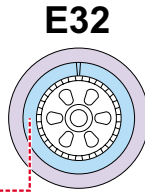
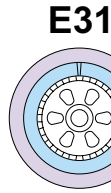
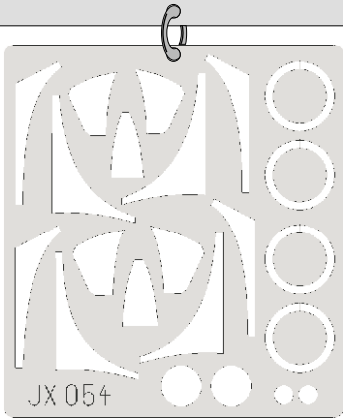

LIQUID MASK

E39

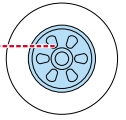
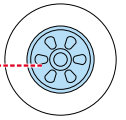

E40

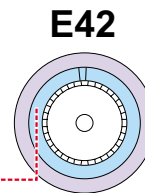
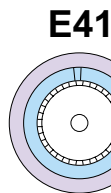

LIQUID MASK

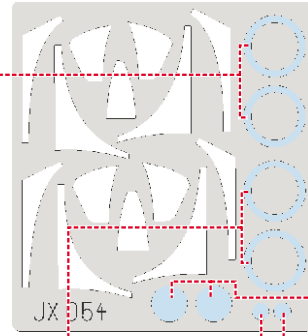

H2

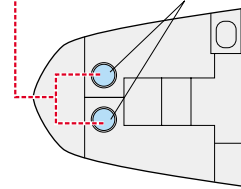

### REFERENCES:

REPLIC #62 / 1996

MODEL ART #302

SQUADRON WALK AROUND #5519

RUBBER COLOR

1.)

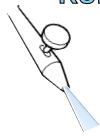

H3

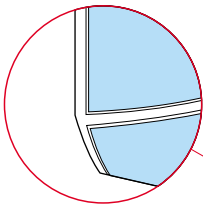

1.)

H6

RUBBER COLOR

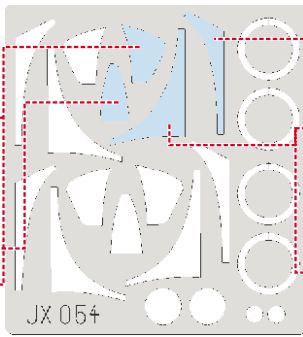
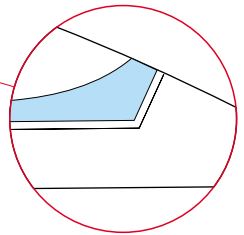

2.)

RUBBER COLOR



H3

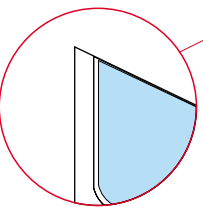

2.)

RUBBER COLOR



LIQUID MASK

H6

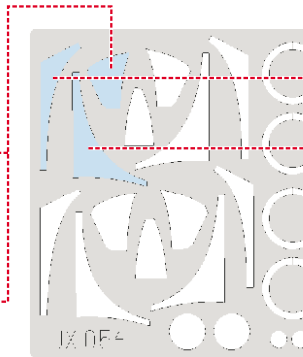
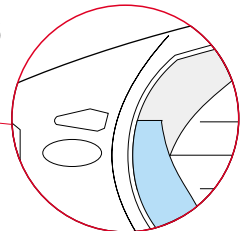

LIQUID MASK

3.)

CAMOUFLAGE COLOR

CAMOUFLAGE COLOR

H3

H6

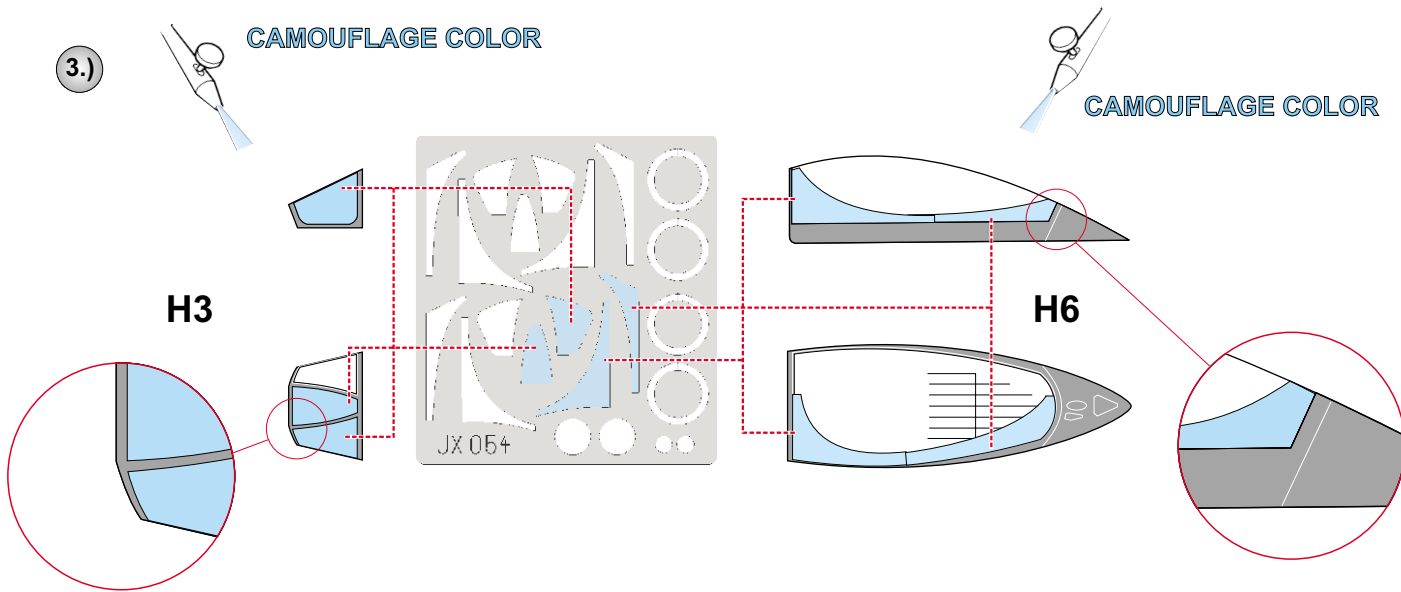

4.)

CAMOUFLAGE COLOR

CAMOUFLAGE COLOR

LIQUID MASK

H3

H6

LIQUID MASK

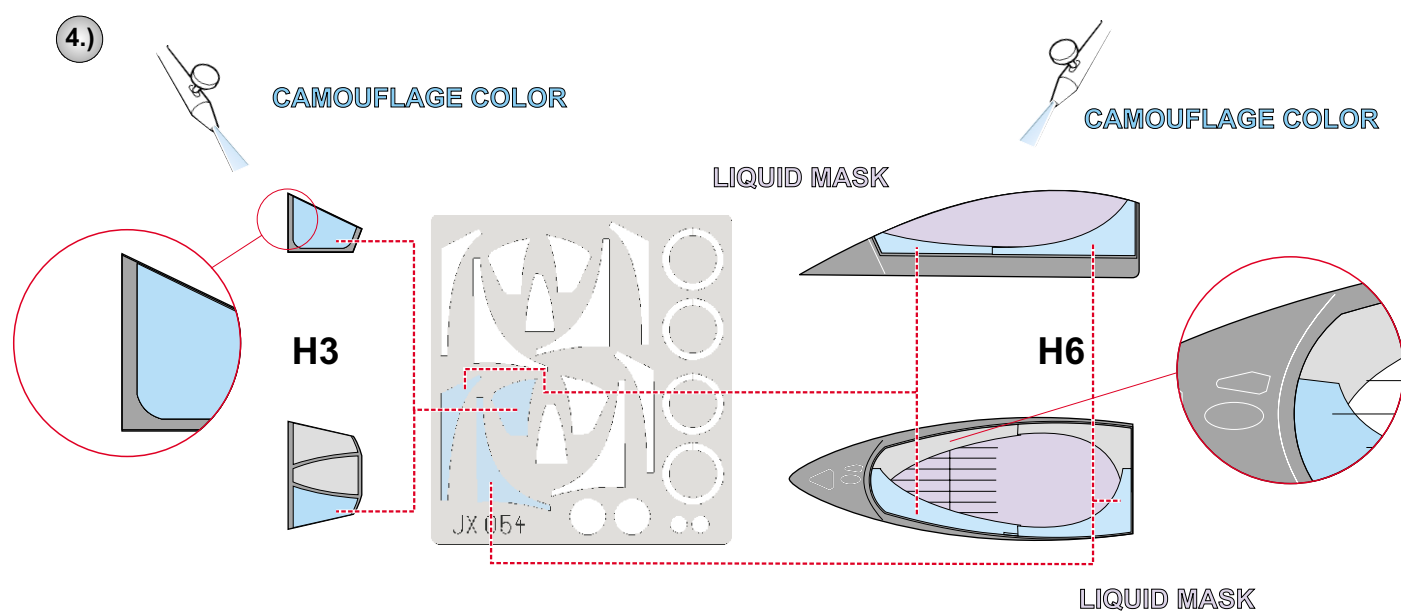

5.)

H3

H6

