



# F-4D interior S.A.

eduard

49 729

detail set for 1/48 ACADEMY No.12300 kit • sada detailů pro stavebnici 1/48 ACADEMY No.12300

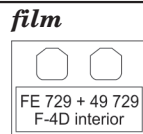
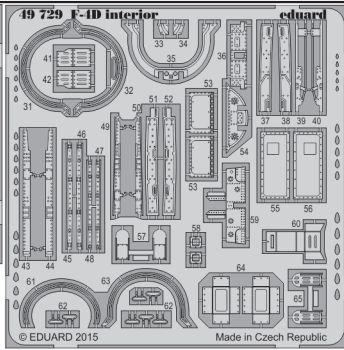
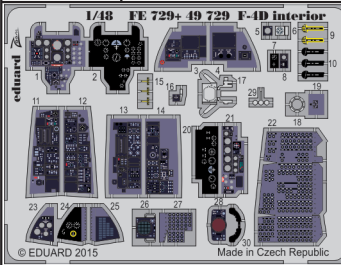

- APPLY EXPRESS MASK AND PAINT BEFORE GLUING  
POUŽIT EXPRESS MASK NABARVIT PŘED SLEPENÍM
- SYMMETRICAL ASSEMBLY  
SYMETRICKÁ MONTÁŽ
- REMOVE  
ODSTRANIT
- GRIND  
OBROUSIT
- DRILL HOLE  
VRTAT OTVOR
- COLORED ETCHED PARTS  
LEPTANÉ BAREVNÉ DÍLY
- ETCHED PARTS  
LEPTANÉ NEBAREVNÉ DÍLY
- ORIGINAL KIT PARTS  
PŮVODNÍ DÍLY STAVEBNICE
- BEND  
OHNOUT
- OPTION  
VOLBA
- REPLACE  
NAHRADIT

ORIGINAL KIT PARTS  
PŮVODNÍ DÍLY STAVEBNICE

PHOTO-ETCHED PARTS  
LEPTANÉ DÍLY

PARTS TO BE REMOVED  
DÍLY K ODSTRANĚNÍ

FILL  
TMELIT

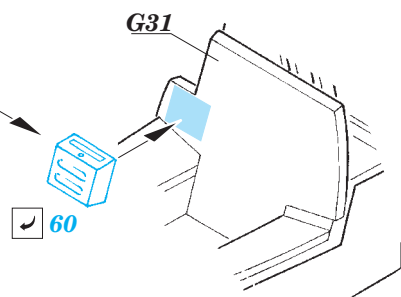
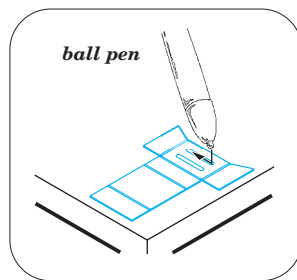
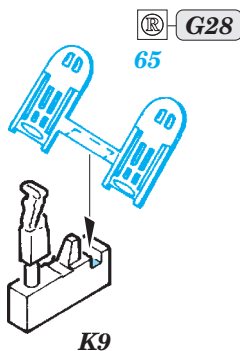
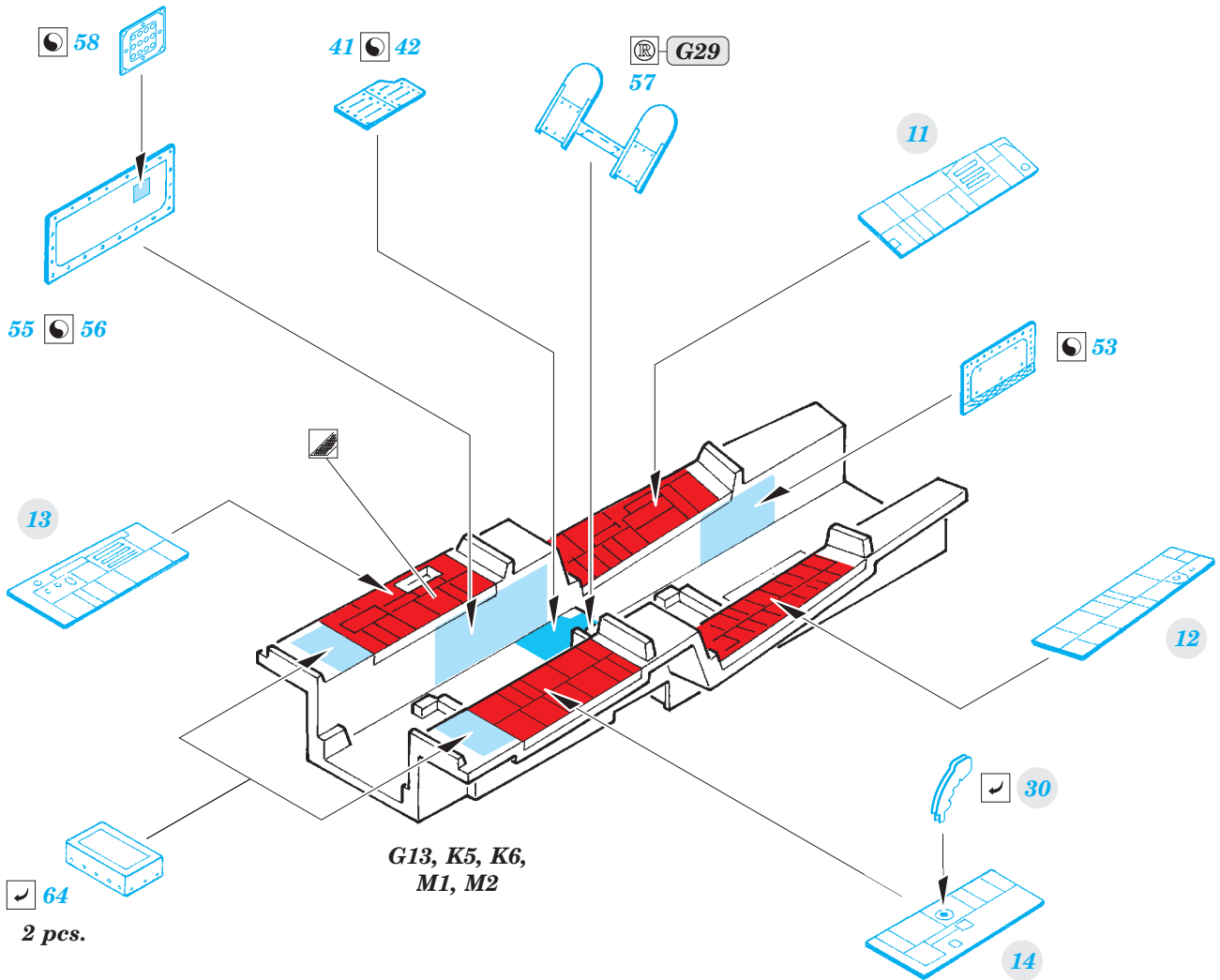

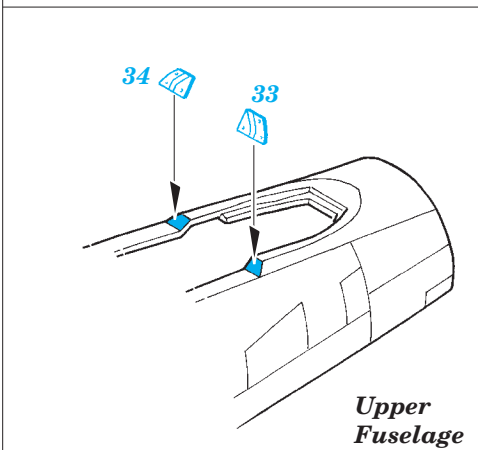
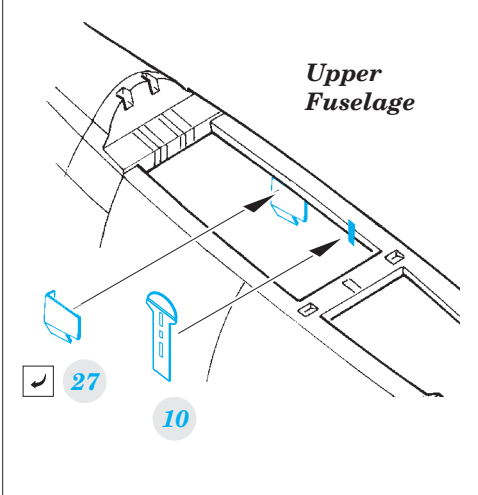
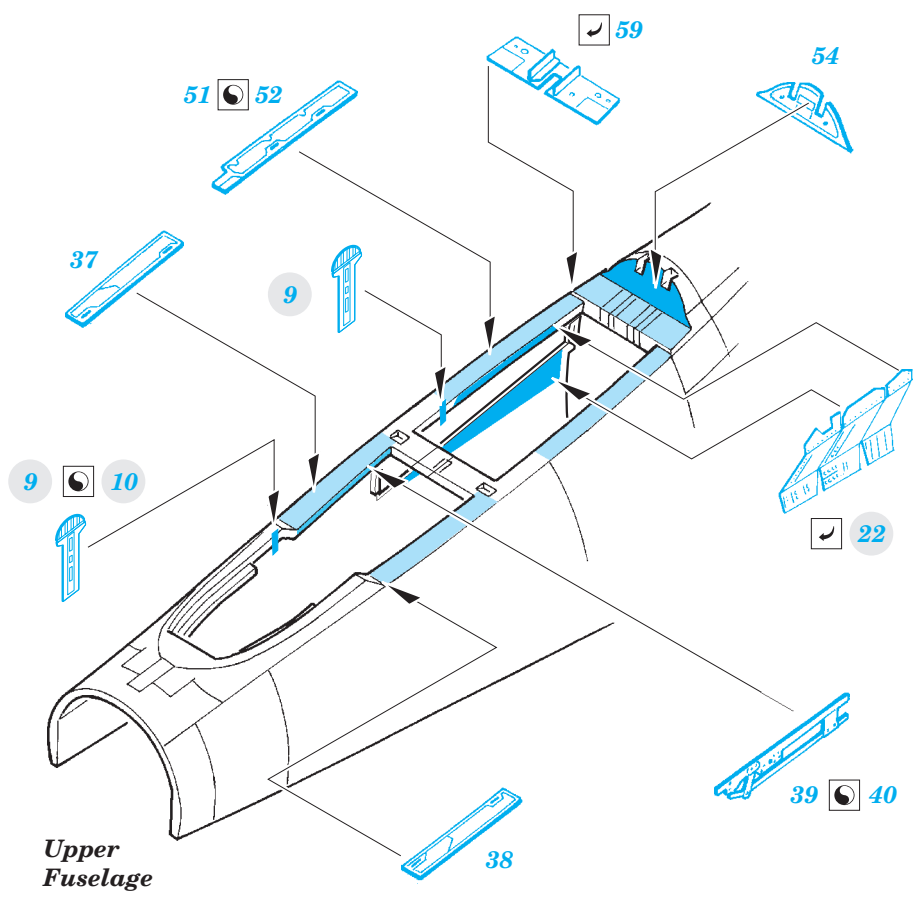
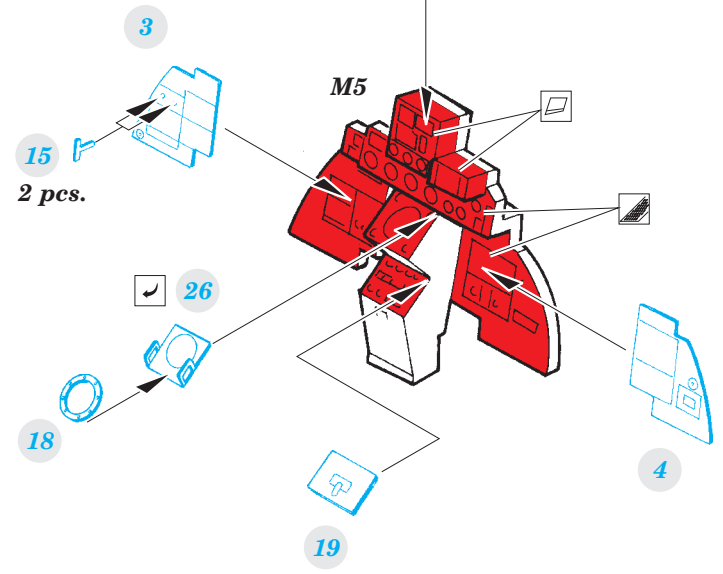
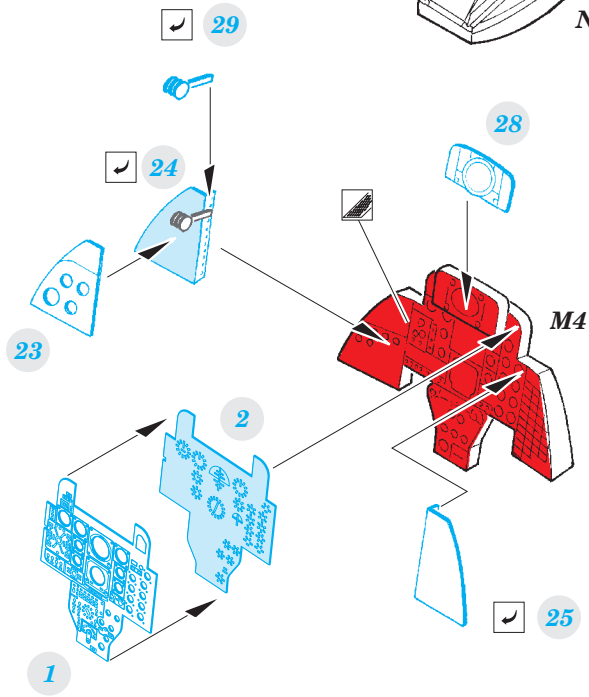
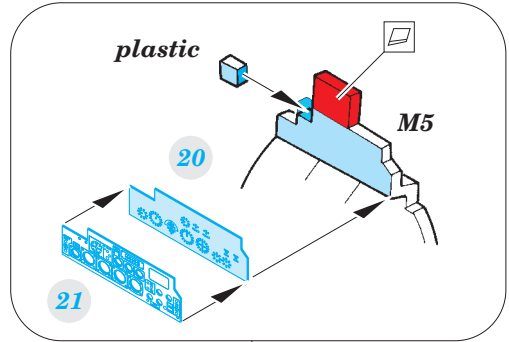
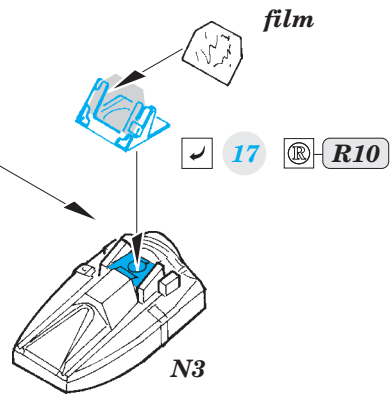
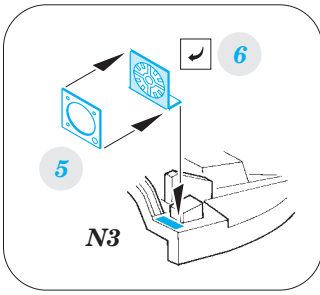

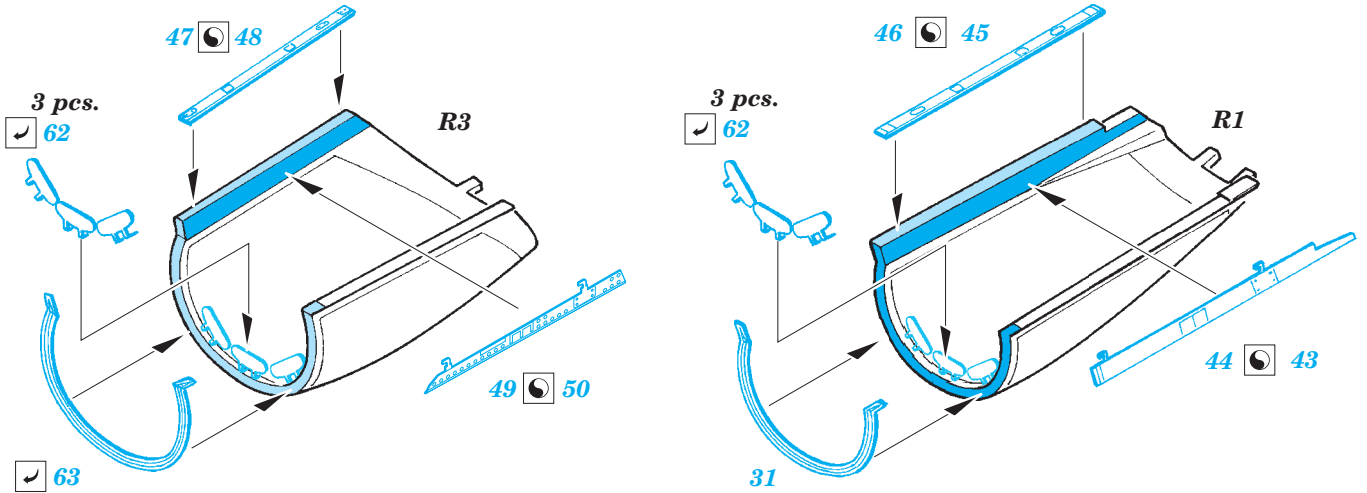
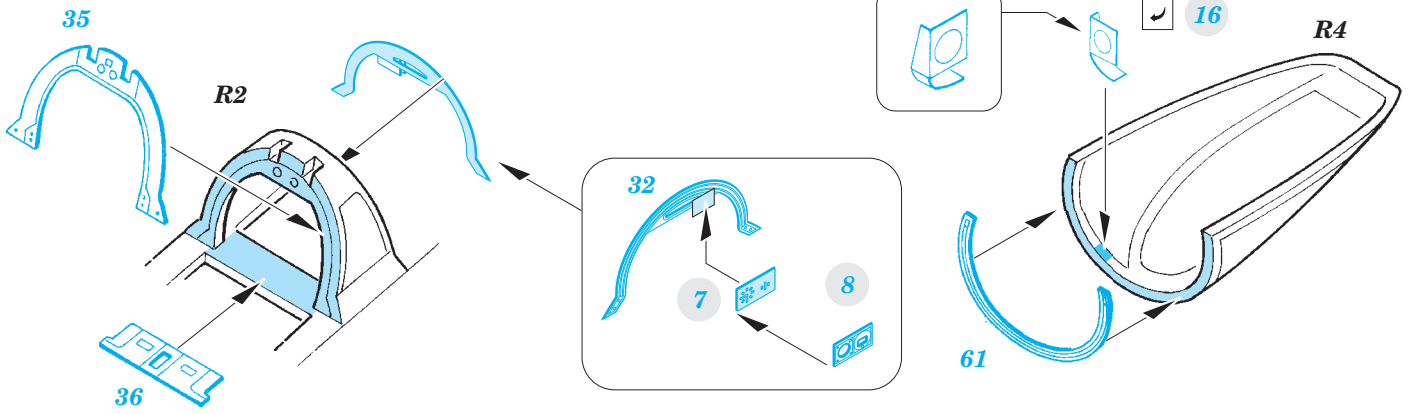

**Related products: 48 855 F-4D air brakes**

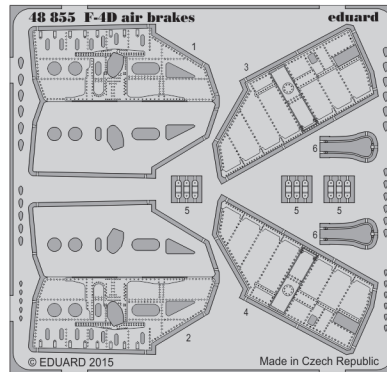

**Related products: 48 856 F-4D exterior**

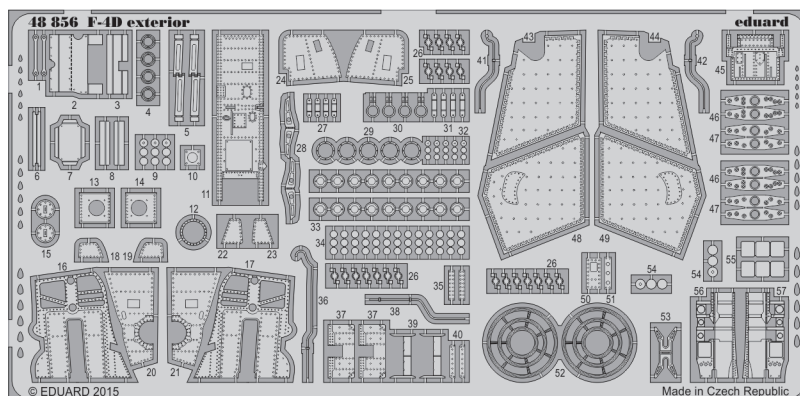

# PARTS WITH GLUE • DÍLY OPATŘENÉ LEPIDLEM

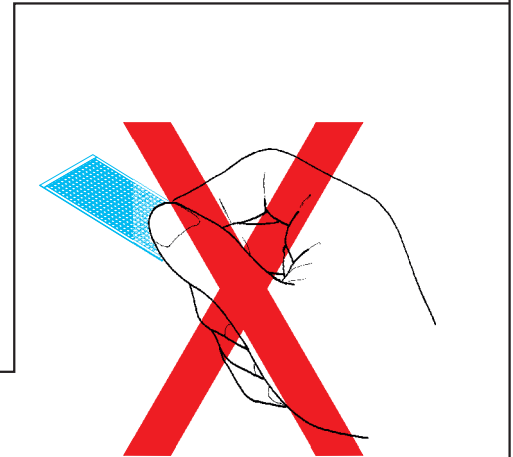
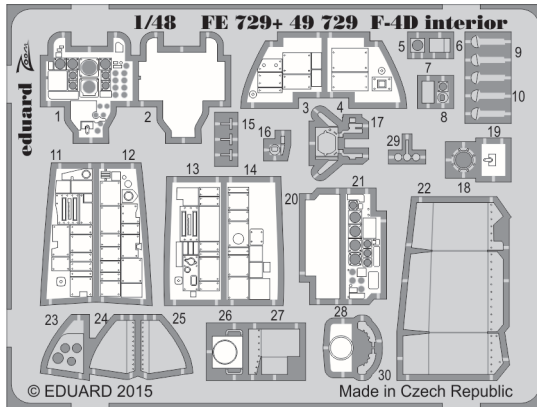

1. Separate the etched components from their frames on the protective paper. Removal from the paper is done only after separation of the parts from the frames.

1. Samolepící díly oddělujte od rámečku na podkladovém papíře. Po oddělení je sejměte z krycího papíru.

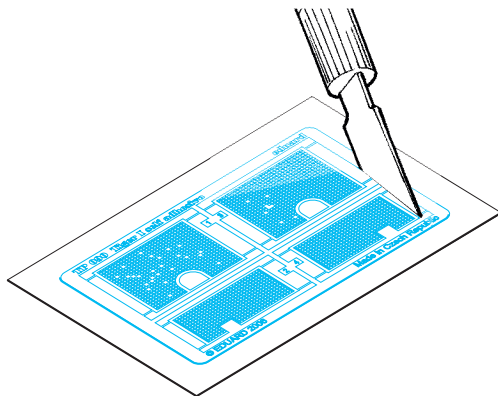

2. Do not inadvertently place etched components on an unwanted surface. Attempts to remove will result in damage to your part.

2. Nepokládejte samolepící díly na volné plochy. Pokud je omylem přilepíte, při pokusu o odlepení dojde k poškození dílu.

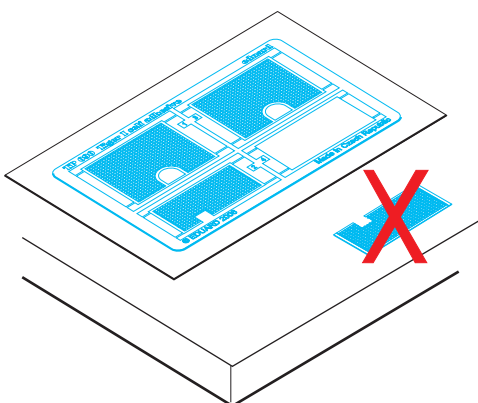

3. Do not touch the adhesive areas of the etched components.

3. Nesahejte na části dílů, na kterých je naneseno lepidlo.

4. Hold the parts by the edges, or at areas free of adhesive.

4. Samolepící díly berte za hrany nebo za části, na kterých není nanesené lepidlo.

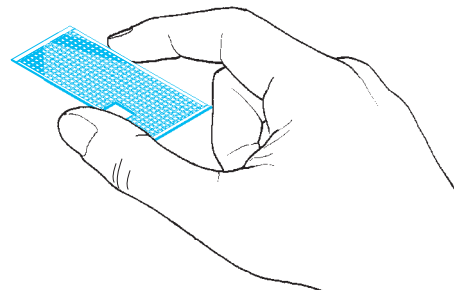

5. Lightly place the component in the desired location and position. Adjust as required. The component will be permanently affixed when pressed onto its intended location, its location can be adjusted.

5. Díl lehce položte do pozice, ve které má být nalepen. Upravte přesnou pozici a přimáčkněte. Díl dokonale přilne až po přimáčknutí, před přimáčknutím lze dílem opatrně manipulovat.

