

eduard  
MASK

# B-25J Mitchell 1/72

The die-cut mask for accurate canopy frame painting of the

*Hasegawa 1/72 KIT*

CX 016

LIQUID  
MASK

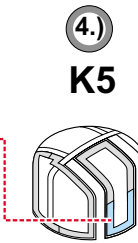
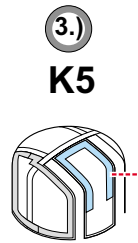
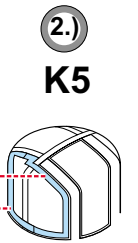
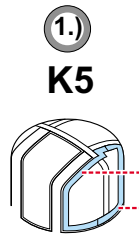
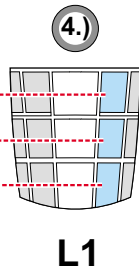
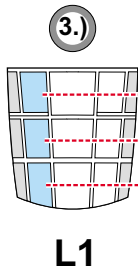
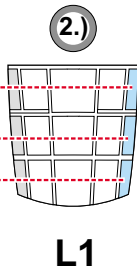
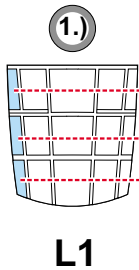
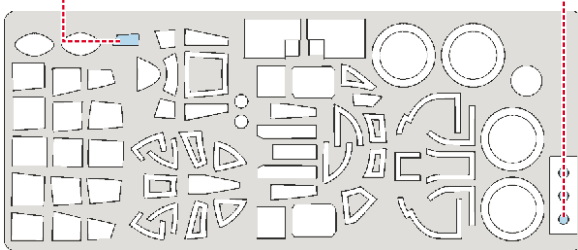
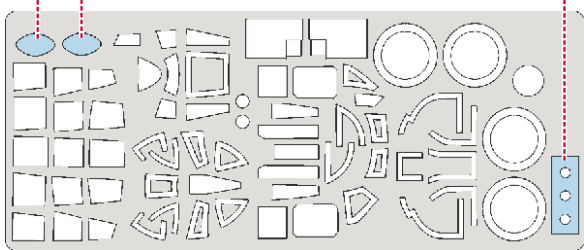
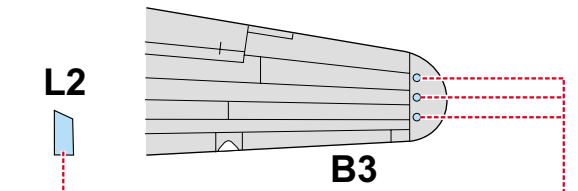
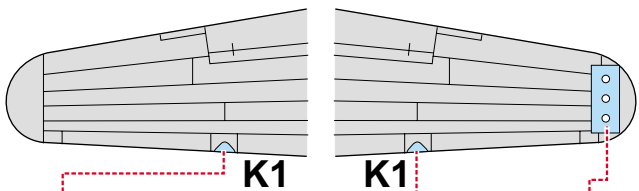
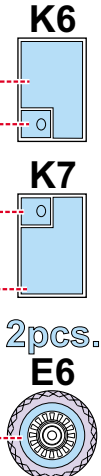
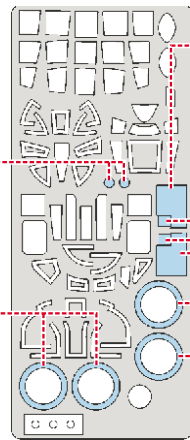
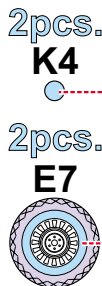
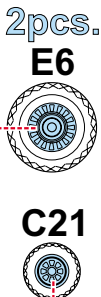
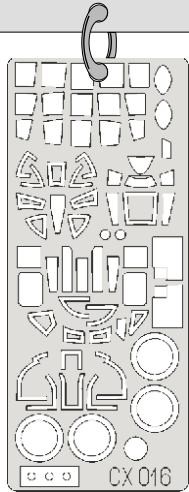

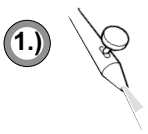
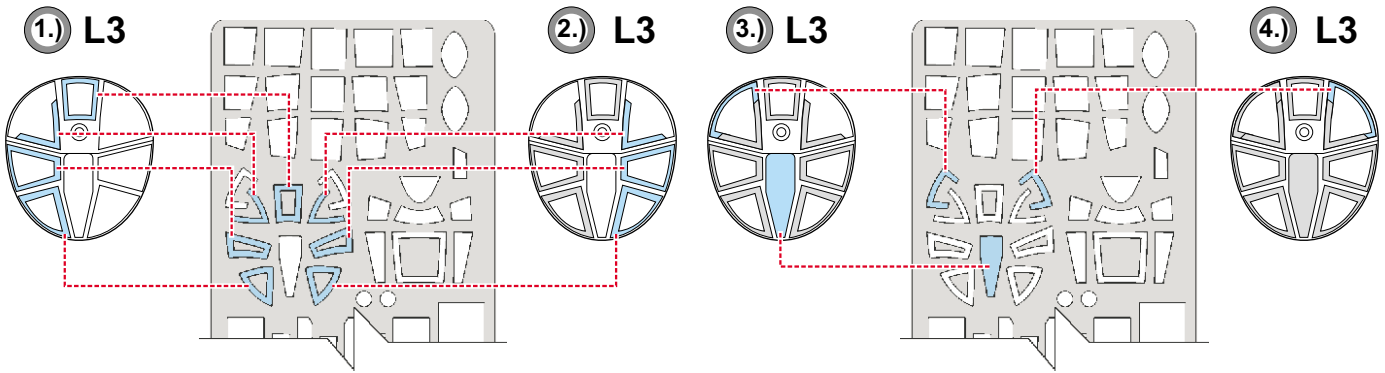
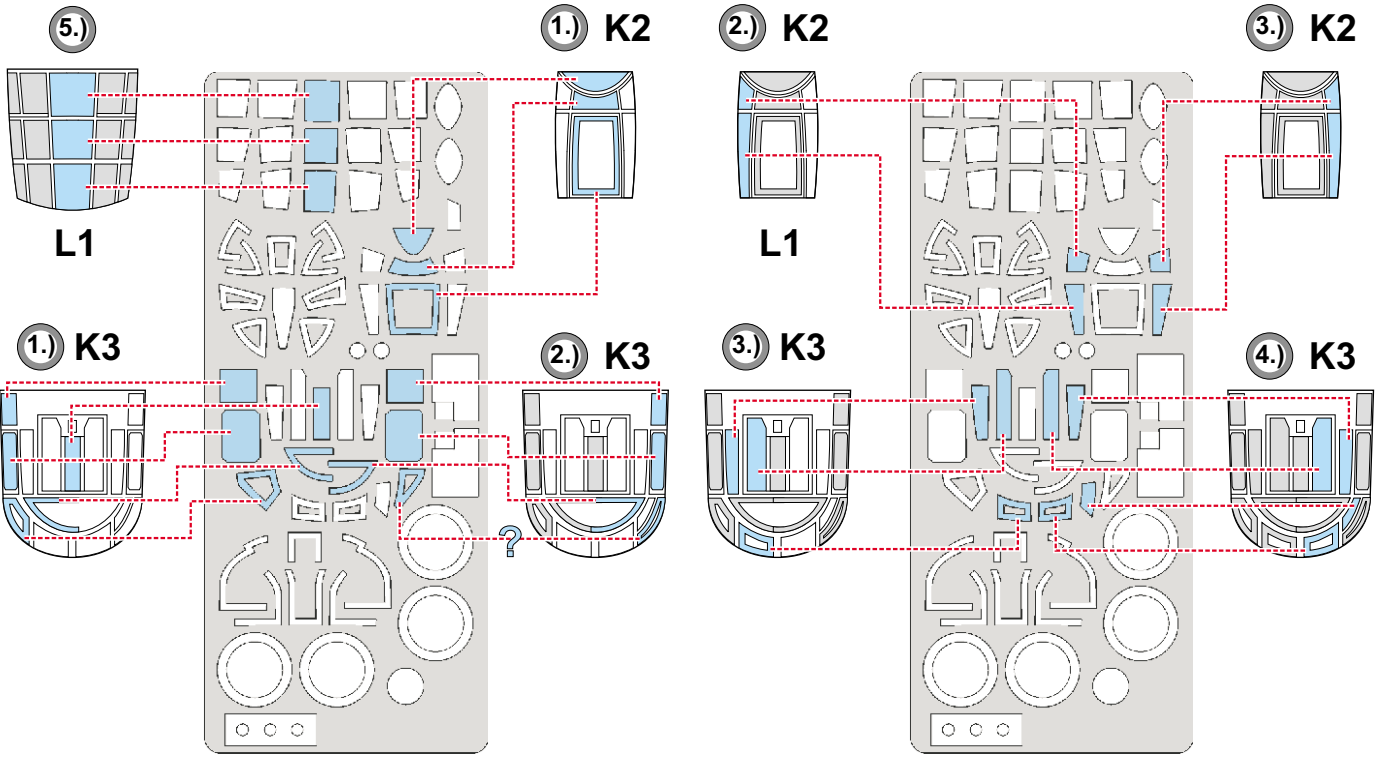

1.) INTERIOR COLOR

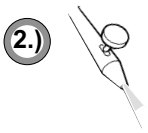

2.) CAMOUFLAGE COLOR

3.)

REMOVE MASK

L1

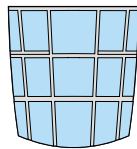

K2

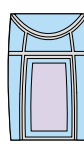

K3

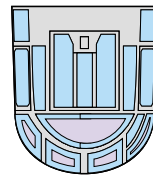

L3

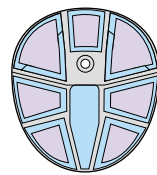

K5

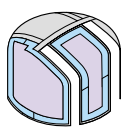

LIQUID MASK ■

L1

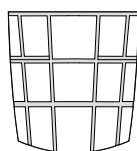

K2

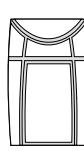

K3

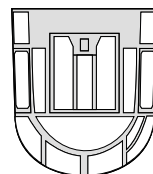

L3

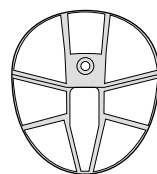

K5

